



800-807-9827

Proudly Built in NH



Veteran Owned

Digital Tempering Systems

Models: TWDT5 / TWDT5 PLUS / TWDT5XL / TWDT5D
1", 1-1/4", 1-1/2", 2", 2-1/2"

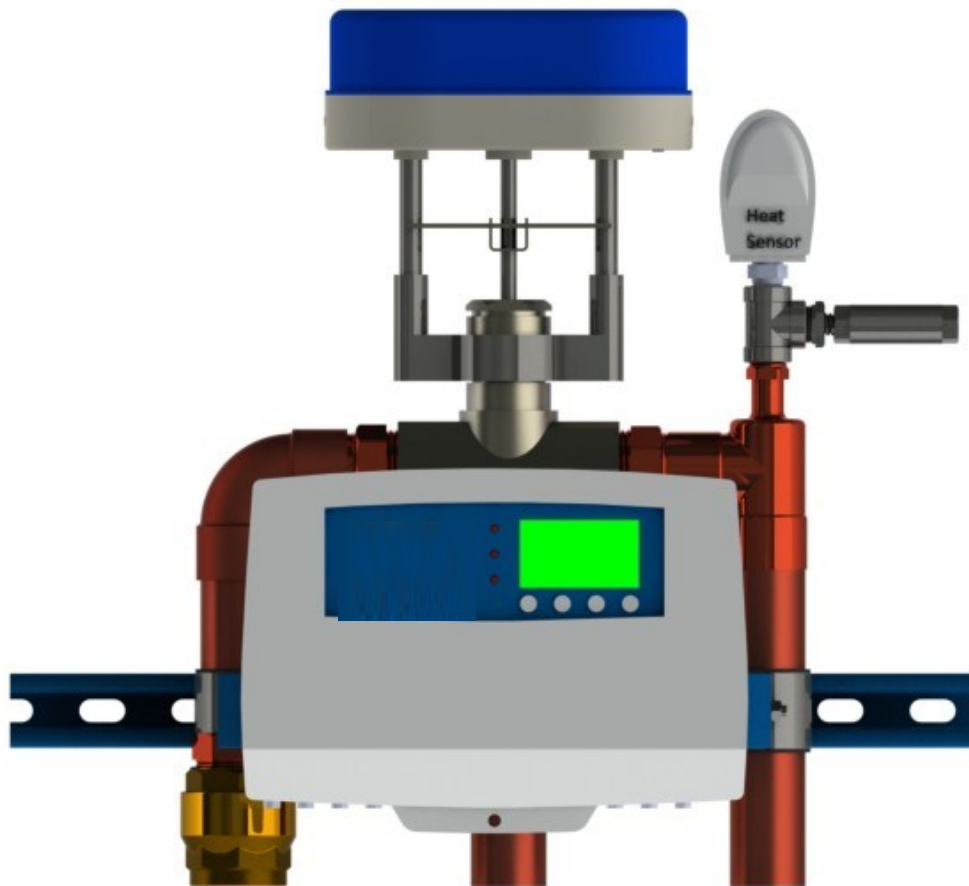

*We can solve your **Hot Water** problems!*



General Information

- ASSE 1017 Approved
- Requires 24/7 circulator pump
 - Circulator pump (supplied by others) must circulate 100% of time.
- System intended to operate below 7.5 FPS (feet per second)
- Recirc line to operate below 5 FPS
- Hot water should be 20°F hotter than tempered water
- Recirc temp should be 7°F cooler than tempered water
- Piping shall be in accordance with recommended diagrams

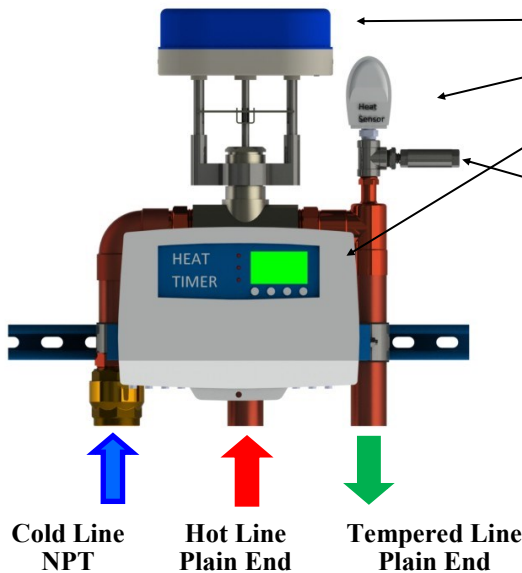

Control Components

- Heat-Timer ETV Actuator 24V
- Heat-Timer Temperature Sensor 24V
- Heat-Timer ETV Control Module 120V
- Modbus, BACnet Internet Compatible

Optional Independent Safety

- 130°F SS Thermal Relief Valve

Plumbing Components:

- Mixing Valve Stainless Steel
- Temperature Sensor Stainless Steel
- Check valves Lead Free Brass
- Ball Valves Lead Free Brass
- Fittings / Piping Copper
- Circulator pump Supplied by others

Model	TWDT S	TWDT S PLUS	TWDT SXL	TWDT SD
Lead Time	1-2 Days	1 Week	1-2 Weeks	1-2 Weeks
Design Approximate Footprint	Wall Mount 2' x 2'	Wall Mount 2' x 2'	Wall Mount 4' x 3'	Wall Mount 2' x 2'
Ball Valves	No	No	Included	No
Recirc line / Boiler Feed	No	No	Included	No
130°F Thermal Relief Valve (other temps available)	No	Included	Included	Included



SIMPLEX

SPECIFICATION - TWDTS

The Digital Tempering System components shall conform to ASSE 1017, CA lead-free plumbing law, and CSA B 125.3. System shall include a 120V digital controller, 304SS piston design mixing valve, and an external 24V worm-gear type actuator. System shall be designed for wall mounting, with the piping capable of orientation down, left, or right. System shall be a Towle Whitney (800-807-9827) model TWDTS. *Option: System shall include an (Internet, BACnet, Modbus) module for remote communication.*

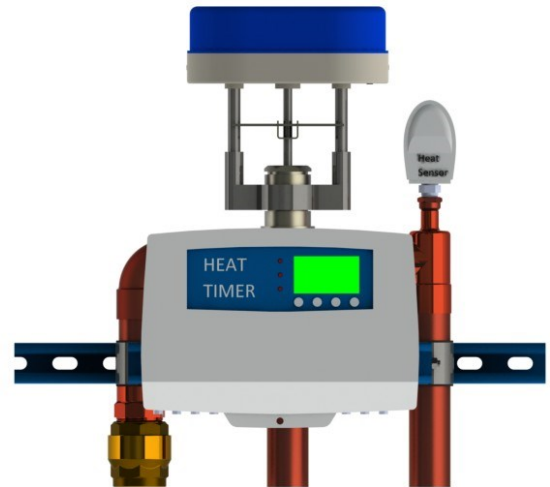

SIMPLEX w/ Safety Valve

SPECIFICATION - TWDTS PLUS

The Digital Tempering System components shall conform to ASSE 1017, CA lead-free plumbing law, and CSA B 125.3. System shall include a 120V digital controller, 304SS piston design mixing valve, external 24V worm-gear type actuator, and a 130°F Thermal Relief Valve (piped to drain by others). System shall be designed for wall mounting, with the piping capable of orientation down, left, or right. System shall be a Towle Whitney (800-807-9827) model TWDTS PLUS. *Option: System shall include a (Internet, BACnet, Modbus) module for remote communication.*

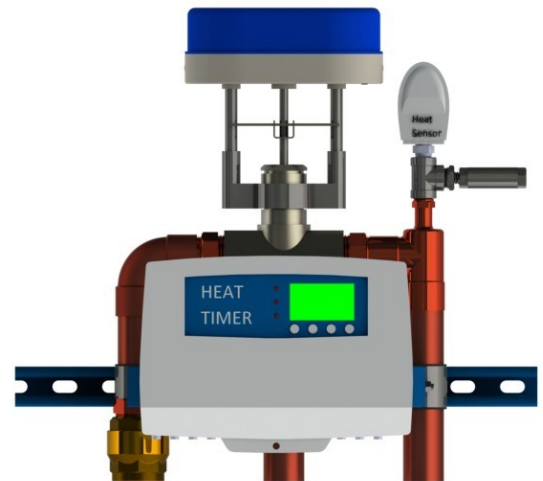

<u>MODEL</u>	<u>COLD</u>	<u>HOT</u>	<u>TEMPERED</u>	<u>FOOTPRINT**</u>	<u>WEIGHT**</u>
TWDTS 100 / TWDTS 100 PLUS	1"	1"	1"	2' X 2'	35 lbs
TWDTS 125 / TWDTS 125 PLUS	1-1/4"	1-1/4"	1-1/4"	2' X 2'	40 lbs
TWDTS 150 / TWDTS 150 PLUS	1-1/2"	1-1/2"	1-1/2"	2' X 2'	45 lbs
TWDTS 200 / TWDTS 200 PLUS	2"	2"	2"	2' X 2'	50 lbs
TWDTS 250 / TWDTS 250 PLUS	2-1/2"	2-1/2"	2-1/2"	2' X 2'	55 lbs

** Footprint and weights are approximate



Recommended Piping Diagram
For TWDTs, TWDTs PLUS, & TWDTSD

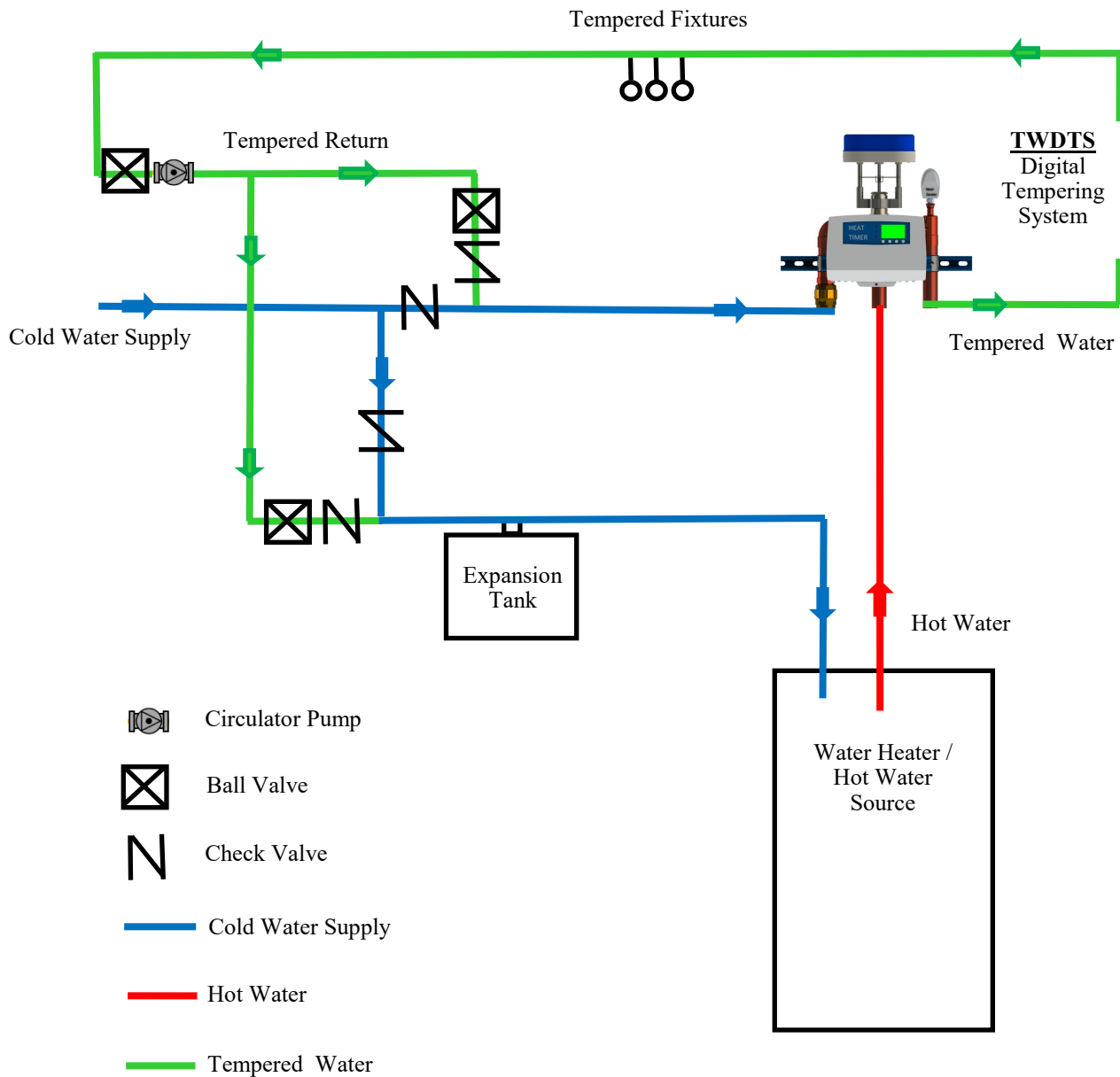



Simplex XL

SPECIFICATION - TWDTS-XL

The Digital Tempering System components shall conform to ASSE 1017, CA lead-free plumbing law, and CSA B 125.3. System shall include piping for hot, cold, tempered, recirc, and boiler feed. Components shall include 120V digital controller, 304SS piston design mixing valve, 304SS temperature sensor, external 24V worm-gear type actuator, thermal safety valve, check valves, and ball valves. System shall be a Towle Whitney model TWDTSXL (800-807-9827). *Option: System shall include an (Internet, BACnet, Modbus) module for remote communication.*

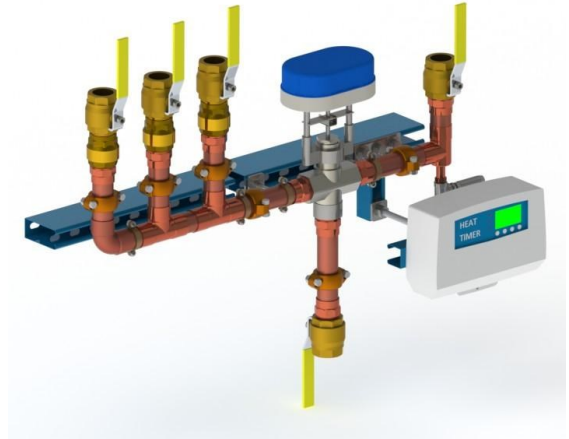

<u>MODEL</u>	<u>COLD</u>	<u>HOT</u>	<u>TEMPERED</u>	<u>RECIRC</u>	<u>FRAME**</u>	<u>WEIGHT**</u>
TWDTS-XL-100	1"	1"	1"	3/4"	36"	70 lbs
TWDTS-XL-125	1-1/4"	1-1/4"	1-1/4"	1"	36"	80 lbs
TWDTS-XL-150	1-1/2"	1-1/2"	1-1/2"	1"	36"	85 lbs
TWDTS-XL-200	2"	2"	2"	1"	36"	95 lbs
TWDTS-XL-250	2-1/2"	2-1/2"	2-1/2"	1"	36"	110 lbs

** Frame and weights are approximate

Recommended Piping Diagram For TWDTS-XL

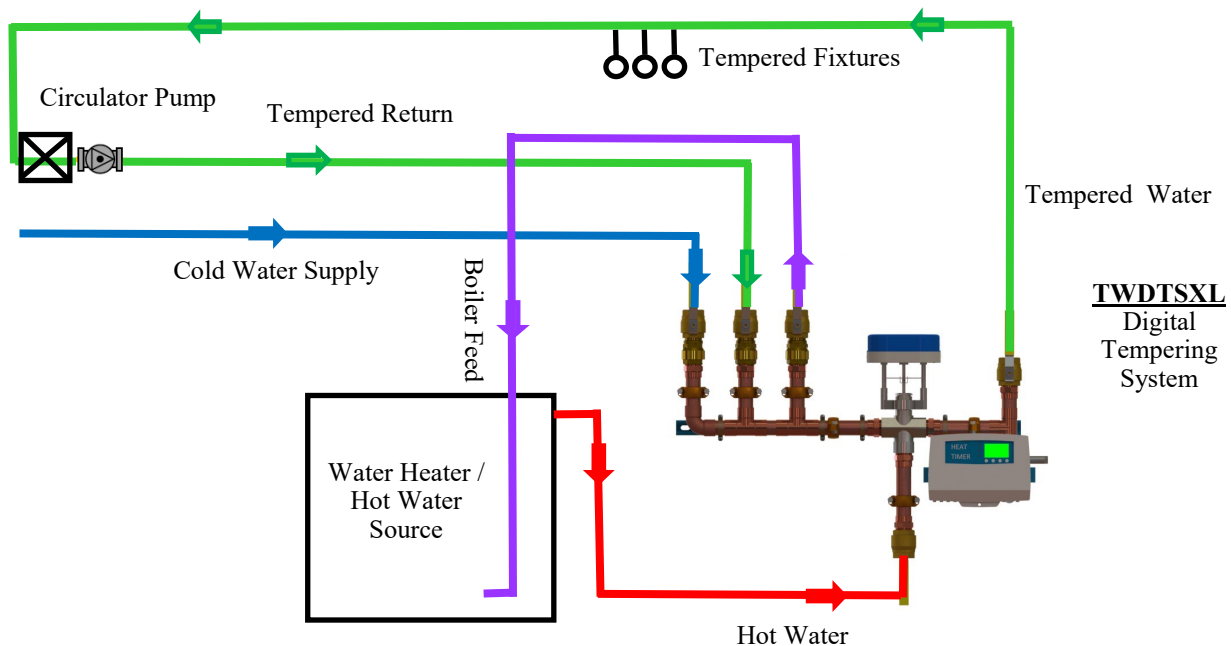



TWDTs Series SIZING

Pressure Drop (psi)	Valve Size						
	½"	¾"	1"	1¼"	1½"	2"	2½"
Cv	5	7	12	18	29	46	73
3	8	12	20	32	50	80	126
4	9	15	23	37	58	93	145
5	10	16	26	41	64	103	162
Gallons per Minute							

Per acceptable plumbing standards, system should be designed to operate at:

- No greater than **7.5 FPS**
- NEVER GREATER THAN 10 FPS**



Why ETV Platinum Plus is Important

Legionella—Selection and controlling proper water temperature in domestic water storage and delivery systems is important in preventing illness from water-borne bacteria such as Legionella.

Scald Hazard—Scald hazards can be created in domestic water distribution systems when not properly controlled or monitored.

Fluctuations—Is the rapid and uncomfortable change in water temperature experienced at the faucet or shower by the end-user, which can lead to a fall or serious injury due to the thermal shock.

The ETV Platinum PLUS allows the domestic water system to be stored at higher temperatures to prevent the growth of Legionella, while being able to control and deliver a consistent tempered water out to the building.

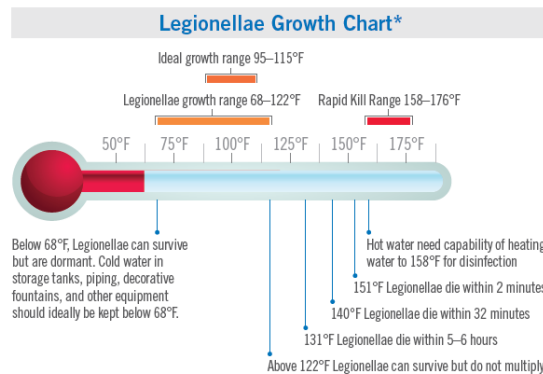

Water Temperature (°F)	Time to 3rd Degree Burn*
155°	1 second
148°	2 seconds
140°	5 seconds
133°	15 seconds
127°	1 minute
124°	3 minutes
120°	5 minutes
100°	Safe temperature for bathing

*As per www.asse-plumbing.org and www.osha.gov



800-807-9827

Proudly Built in NH



Veteran Owned

TWDTs Digital Tempering Stations

One Year Limited Warranty

This warranty applies to TWDTs Series provided by Towle Whitney LLC, and shall:

- Exist 12 months from the date of shipment.
- Be in effect only after installation photographs are received by Towle Whitney LLC.

It is the user's responsibility to adjust the controllers settings to provide the proper amount of tempered water to the building.

Towle Whitney LLC liability under this warranty shall be limited to the repair or replacement of any part or parts found to be defective (material or workmanship) within the warranty period. Towle Whitney LLC shall determine whether the part needs to be returned, or field scrapped. The warranty excludes:

- Debris in water causing mixing valve damage.
- Any water damage or consequential damage.
- Systems not installed in accordance with Installation and Maintenance Instructions.
- Labor, transportation, and related costs incurred by the customer.
- Misuse, negligence, inappropriate chemicals or additives in water.
- Inadequate protection from freezing.
- Lightning, high voltage spikes, accidents, floods, or acts of God.
- Re-Installation costs of repaired or replacement equipment.
- Re-Imbursement for the loss caused by interruption of service.

This warranty applies to all states and territories of the United States and Canada only. There are no express or implied warranties, including merchantability or fitness for a particular purpose, which extend beyond those warranties described or referred to above.

Some jurisdictions do not allow the exclusion or limitation of incidental or consequential damages and some jurisdictions do not allow limit actions on how long implied warranties may last. Therefore, the above limitations or exclusions may not apply. This warranty gives you specific legal rights and you may also have other rights which vary from jurisdiction to jurisdiction.

TWDTs 0119

800-807-9827

21 Londonderry Turnpike, Hooksett, NH 03106
towle-whitney.com

info@towle-whitney.com